



Emaux

water technology



VOLUMETRIC FILTER

T 型过滤器

MODELS:

T450

T500

T600

T700

T600B

T700B

WARNING - Read and follow all instructions in this owner's manual and on the equipment. Failure to follow instructions can cause severe injury and/or death.

WARNING - Never operate or test the circulation system at more than 4 bar.

WARNING - Never change the filter control valve position while the pump is running.

WARNING - Hazardous Pressure. Due to the high operation pressure, some components from the pump or the filter could be violent separated.

Do not operate the pool equipment if a system component is not assembled properly, damaged, or missing.

警告 - 阅读并遵守本用户手册和设备上的所有说明。不遵守说明可能会导致严重受伤和/或死亡。

警告- 切勿在超过4 bar时操作或测试循环系统。

警告- 切勿在水泵运行时更换沙缸控制阀位置。

警告- 危险压力。由于高压操作，一些来自水泵或沙缸的部件可能剧烈分离。

如果系统组件未正确组装，损坏或丢失，请勿操作水池设备。

1.MAIN FEATURES: 主要特点:

Our Volumetric filter (fig.1) is a one-piece blow moulded filter made in high density polyethylene material manufactured to maximize the strength of the filter.

我们的T型胶缸（图1）是一个以HDPE材料制造的一体式高密度吹塑胶缸，能使强度最大化。

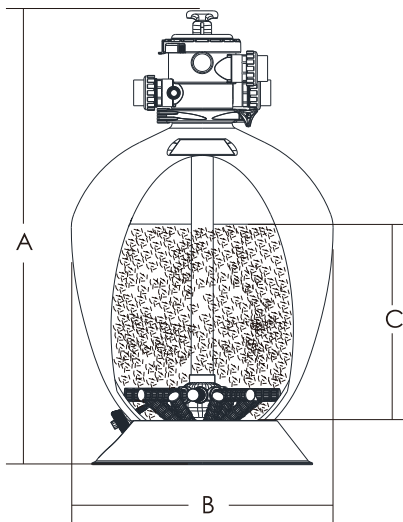

Fig 1. Volumetric filter (图1)

Product dimensions:

Model	A (mm)	B (mm)	C (mm)
T450	954	457	353
T500	1040	508	400
T600	1090	610	457
T700	1180	711	516
T600B	1142	610	457
T700B	1232	711	516

1.1.TECHNICAL FEATURES: 技术特点:

VOLUMETRIC FILTER						
Code	Model No.	Filtration area (m ²)	Valve connections	Max. working pressure (bar)	Max. Flow rate (m ³ /h)	Sand (kg)
产品编号	型号	过滤面积	阀门接头	最大工作压力	最大流量	沙重
88016003	T450	0.16	1.5" / 50 mm	4 bar	8	75
88016004	T500	0.2			10	95
88016046	T600	0.29			14.6	165
88016007	T700	0.39			19.5	200
88016047	T600B	0.29	2" / 63 mm		14.6	165
88016008	T700B	0.39			19.5	200

1.2. DOUBLE LAYERED FILTER: 双层沙缸：

Due to the double-layered lateral arms (fig. 2), the filtration bed is higher than other standard sand filters, offering a better quality of water and less frequency of backwash at the same conditions.

双层侧臂（图2）使其过滤床高于其他标准沙缸，在相同条件下能提供更好的水质和更少的倒冲洗率。



(图2) Fig 2. Double layered lateral arms

1.3. SPECIAL DRAIN CONNECTION: 特殊排水连接：

Its special design allows to remove the water and also the sand from inside the filter through the connection drain (Fig. 3).

Removing the drain lid, only the water will come out from the filter. Unscrew the plastic filter with the cap of the lid for removing the sand (Fig. 4).

其独特设计能使水和内部的沙透过连接口排清（图3）。

卸下排水盖后，只有水会来从沙缸中排出。打开盖顶将沙排出（图4）



(图3) Fig 3. Filter drain



(图4) Fig 4. Filter drain components

1.4. MULTI PORT VALVE: 多端口阀：

The filters incorporate a 6-ways multiport valve (Fig. 5) which covers all the necessary operations related with the filtration procedure: filtration, backwash, rinse, waste, recirculate and close (Fig. 6)

沙缸的6路多端口阀（图5），覆盖所有必要的过滤相关操作：正常过滤，倒冲洗，底管清洗，无过滤排水，无过滤循环和关闭（图6）



(图5) Fig 5. Multiport valve



(图6) Fig 6. Handle with all the possible positions

2. INSTALLATION: 安装:

It is recommended to install the filter as close as possible to the swimming pool and preferably below the surface of the water in the swimming pool and in such a way that the base lies completely stable upon a totally horizontal surface.

The place where the filter is installed should have enough ventilation and adequate drains so that, in case of an accident, the water can escape through the drain system, avoiding risk of damaging the installations.

Install the filter in a place with space enough to carry out the operation and maintenance services.

Sand should be loaded once the filter is installed into its exact location, following the instructions in the "SAND LOAD".

建议安装于最接近游泳池的位置及于水下方，这可使基座完全稳定于完全水平的表面上。

安装处应有足够的通风和水管以排水，使得于意外事故的情况下，水能通过排水系统排出以避免损坏设备的风险。

安装在具有足够空间执行操作和维修处理的位置。

当沙缸安装好后，跟随“SAND LOAD”的指示将砂子加进。

2.1. ASSEMBLY: 装配简介:

To assembly of the filter, proceed as follows:

- 1.- Some lateral arms could be not completely threaded. Check all the connections and thread them if necessary.
- 2.- Install the O´ring supplied in the plastic box together with this manual, between the valve multiport valve and the filter.
- 3.- Move the valve and place it so that the connections are in the proper direction.
- 4.- Tight the clamp of the valve to the filter with the Star-Shaped Nut.
- 5.- Assembly the three connections of the selector valve. Each of these three outlets is clearly identified on the valve as follows.
 - (1) "PUMP": It is the connection of the pipe which comes from the filtration pump.
 - (2) "WASTE": it is the connection of the pipe which is going to the drain.
 - (3) "RETURN": it is the connection of the pipe going back to the pool.
- 6.- Assembly the manometer and the sight glass. Install their respective O´rings.

按以下步骤组装沙缸:

- 1.- 一些侧臂不能完全装入。检查所有连接并装入如有需要。
- 2.- 将胶圈安装在多功能阀门和胶缸之间(胶圈随此使用手册的胶盒内附上)。参考2.2胶缸与缸头装配。
- 3.- 移动并正确放置阀门，使连接处于正确的方向。
- 4.- 用星形螺母将阀的夹子拧紧。
- 5.- 将三个连接组装在阀上。这三个阀门上的连接口明确标识如下：
 - (1) “水泵”：这是来自过滤泵的管道的连接；
 - (2) “排水口”：这是排水管的管道的连接；
 - (3) “返回”：这是管道的连接返回到泳池中；
- 6.- 装配压力计和观察镜及安装其相配的小孔。

2.2. Assembly between Filter Tank and Valves: 胶缸与缸头装配:

1)Preparation stage: apply lubricant or Vaseline on the assemble(Outer) surface of the valve and the inner surface of the Y shaped ring, as diagram 7,8 and 9

1)准备阶段，缸头装胶圈面涂上润滑脂或凡士林，在Y型胶圈内侧面涂上润滑脂或凡士林，已切好的胶缸颈口，如图7、8、9



Fig. 7

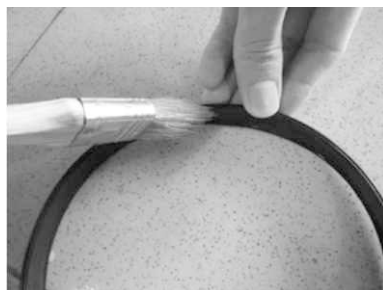

Fig. 8



Fig. 9

2)Assembly Stage: Place the Y shaped Ring into the neck of the filter tank, insert the valve vertically into the filter tank, apply the force with hands equally, please note cannot add too much force on one side since that will easily break the Y shaped ring, Is special to Notice:the trumpet is with a downward exposure as diagram 10,11 and 12

2)装配阶段：Y型胶圈套在胶缸颈口上，套好后，缸头从颈口上方垂直插入，用手压紧，注意用力要均匀，不能偏向一边，用力偏向一边容易挤坏胶圈，特别注意：喇叭口朝下如图10、11、12



Fig. 10



Fig. 11



Fig. 12

3) Assemble the Clamp Lock closely, as diagram 13
3) 装颈环夹锁紧, 如图13



Fig. 13

2.3. SAND LOAD: 注沙:

In order to obtain maximum efficiency from your filter, it should be filled with silica sand or glass with a granulometry 0,5 – 0,8 mm.

The total amount of silica sand is indicated on the specifications label of the filter, as well as in this User Manual (see chapter MAIN FEATURES).

For loading the filter with sand, proceed as follows:

- 1.- Load up the filter with silica sand when it is already installed in its final position.
- 2.- Take off the multiport valve lid and the joint.
- 3.- Install the protector lid supplied in the plastic bag together with this manual. The protector lid matches perfectly with the neck of the filter and protects the central pipe of the filter from the silica sand.
- 4.- Fill the filter with water to half capacity.
- 5.- Slowly pour the required quantity of sand inside the filter.
- 6.- Remove the protector lid and install the multiport valve connected with the central pipe of the filter.
- 7.- Tight the clamp of the valve to the filter with the Star-Shaped Nut.

为使沙缸效率最大化, 应注入硅砂或玻璃, 粒度为0.5-0.8mm硅砂的总量在沙缸上的规格标签上以及本用户手册(参见主要特性一章)标明请按以下步骤将沙注进沙缸:

1. - 当过滤器已经安装在其最终位置时, 用硅砂装载于沙缸里。
2. - 取下多端口阀盖和接头。
3. - 安装附于本手册之胶袋中的保护盖。保护盖能完善连接缸颈, 并保护硅砂所形成的中心管
4. - 将水加至一半容量。
5. - 将所需数量的沙缓缓倒入沙缸内。
6. - 移除保护盖, 并安装与中央连接的多端口阀管道。
7. - 用星形螺母将阀的夹子拧紧。

3. OPERATION PROCESS: 操作步骤:

The multiport valve has a handle of 6 positions that selects any of the necessary operations to obtain the maximum efficiency from the filter.

多功能阀门拥有6个位置让沙缸发挥最大效益

IMPORTANT: When changing the position of the multiport valve, always switch off the pump before.

重要: 当转换多功能阀门的位置时, 请先把水泵关掉。

POSITION 1: FILTRATION 正常过滤

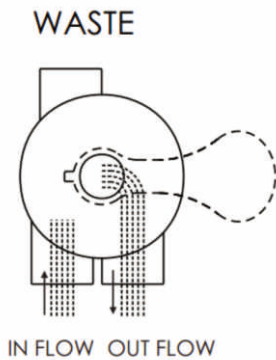

With the pump switched off, place the handle of the multiport valve in the "Filtration" position.

先关掉水泵，将手柄转至“正常过滤”的位置。

Switch on the pump. 开启水泵。

During filtration, it is recommended to check the pressure gauge from the multiport valve. The silica sand forms thousands of channels while the water is descending through the filter, and retains the suspended solids (SS). For time being, quantity of suspended solids retained in the sand increases and block the channels. This is why the pressure raises up inside the filter.

当过滤时，建议检查多功能阀门的压力表。

When the pressure gauge reaches 3.5 bars (50 PSI), the filter is saturated and it needs to proceed with the backwash.

当压力表达至3.5bar(50psi)，沙缸处于饱和状态，这时需要反冲洗。

POSITION 2: BACKWASH 倒冲洗

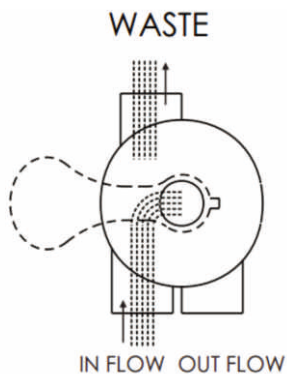

At this pressure the silica sand is unable to collect more impurities and must be washed as follows:

1.- Switch off the filtration pumps.

2.- Turn the multiport valve handle to the "BACKWASH" position.

3.- Switch on the pump and run it for around 2 minutes. The quality of the water wasted can be checked in the sight glass placed in the waste connection of the multiport valve.

4.- When this operation is completed, the dirt blocking the filter will have been removed.

在这压力下水晶砂不能再收集杂质，需要清洗如下：

1-关掉水泵。

2-将手柄转至反冲洗的位置。

3-启动水泵并运行大约2分钟。可以在透视镜检查水质。

4-操作完毕后，阻塞沙缸的污秽将被清除。

POSITION 3: RINSE 底管冲洗

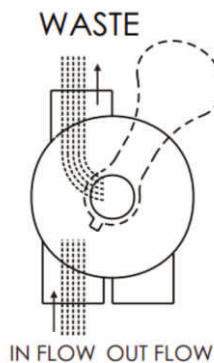

After the carrying out the backwash operation on the filter, the water will be cloudy for a few seconds. Rinse prevents this water coming to the pool. Rinse is recommended immediately after the backwash for 1 minute.

当在沙缸完成反冲洗操作后，水会变浊几秒，底管冲洗防止污水流进泳池。建议在反冲洗后马上作1分钟的管底冲洗。

POSITION 4: RECIRCULATE 无过滤循环

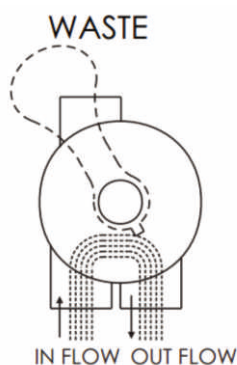

In this position, the multiport valve allows the water from the pump to go directly to the swimming pool without passing through the inside of the filter.

在这位置，多功能阀门容许从水泵吸入的水不经沙缸内部直接流至泳池。

POSITION 5: WASTE 无过滤排水

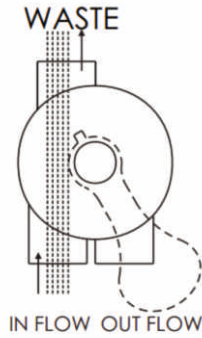

If the swimming pool needs to be drained, the multiport valve must be in this position. When draining, the main drain valve is fully open, for the pump to have sufficient suction. On the other hand, the skimmer valves and the bottom cleaner valves must be close in order to avoid air suction.

如游泳池需要排水，需要转动多功能阀门至这位置。排水时，需要完全打开主排水，让水泵有足够的吸力。另一边，撇渣器的阀门及底部的阀门需要关闭以防止空气的吸力。

POSITION 6: CLOSED 关闭过滤

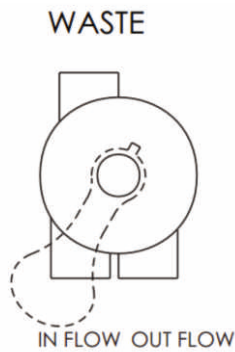

This position is for closing off the water from the filter to the pump and it is used when opening the pump strainer or for installation maintenance.

这位置是安装或维修时阻止水由沙缸流向水泵。

4.START-UP: 开始:

When the filter has been loaded, the sand must be washed for 4 minutes.
安装沙缸后，需冲洗沙4分钟。

Proceed with the backwash as mentioned (OPERATION PROCESS).
进行“反冲洗”(操作过程)

When this has been done, the filter will be ready to operate.
当完成后，沙缸已准备运作。

IMPORTANT: The pump should be switched off when changing the position of the multiport valve.

重要：转动多功能阀门的位置时水泵需保持关闭。

5.MAINTENANCE: 保养:

Always replace the joints and pieces that may not be in good condition.
Backwash and rinse when is required according to the pressure gauge indications.
It's recommended to change the sand inside the filter approximately every 3 years.

需要经常更换已坏的连接或配件。
根据压力表的指示而进行反冲洗及底管冲洗。
建议大约3年更换沙缸的沙。

6.WINTERIZING: 防冻:

Before stop operating the filtration system for a long period of time, proceed with a backwash and a rinse as previously detailed.

Remove the water from the filter by using the drain connection.

Take off the multiport valve to ventilate the filter in the period of inactivity.

Move the handle of the multiport valve to the position WINTER.

When you need to start up the filter again after a period of inactivity, follow the instructions detailed in "START UP".

在长时间停止运作循环系统前，进行反冲洗及管底冲洗如前述。

利用排水连接除去沙缸的水。

将多功能阀门的手柄移向WINTER的位置。

当你需要重启长时间停止运作的沙缸时，请跟从“开始”的指示。

7.REPLACEMENT PARTS: 替换零件:

Item	Part No.	Description	Qty
1	88281550	6 Way 1.5" Top Mount Valve	1
1	88281551	6 Way 2" Top Mount Valve	1
2	06011031	Maximum 100PSI Indication, Stainless Steel Casing	1
2	89280120	Drain Plug Fitting with O-ring	1
3	89280102	1.5" union set with O-ring	3
3	89280103	2" union set with O-ring	3
4	03021035	M6 Nut	1
5	E010117	Clamp Kit	1
6	01111101	Star-Shaped Nut	1
7	112000017	M6×125mm Screws	1
8	111000016	O-Ring	1
9	E010501	Filter Tank for T450	1
9	E010502	Filter Tank for T500	1
9	E010503	Filter Tank for T600/T600B	1
9	E010504	Filter Tank for T700/T700B	1
10	E010118	Lateral Assembly with Center Pipe for T450	1
10	E010119	Lateral Assembly with Center Pipe for T500	1
10	E010120	Lateral Assembly with Center Pipe for T600	1
10	E010121	Lateral Assembly with Center Pipe for T700	1
10	E010122	Lateral Assembly with Center Pipe for T600B	1
10	E010123	Lateral Assembly with Center Pipe for T700B	1
11	01172007	Laterals (115mm) for T450/T500/T600/T700	8
11	01173078	Laterals (148mm) for T600B/T700B	8
12	01172008	Laterals (126mm) for T450/T500/T600/T700/T600B/T700B	8
13	E010024	Water Drain Set	1
14	01112133	Filter Base T450/T500	1
14	01112134	Filter Base T600/T700/T600B/T700B	1
15	01018066	Nut for Filter Base	1

NOTE: T450 / T500 / T600 / T700 should have 8pcs of lateral (115mm) and 8pcs of lateral (126mm)

T600B / T700B should have 8pcs of lateral (148mm) and 8pcs of lateral (126mm)

